

R.O.H.S.

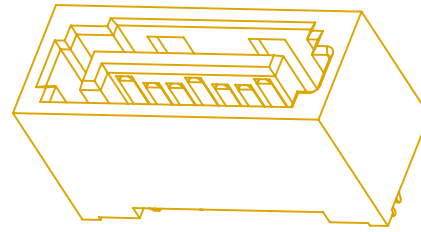
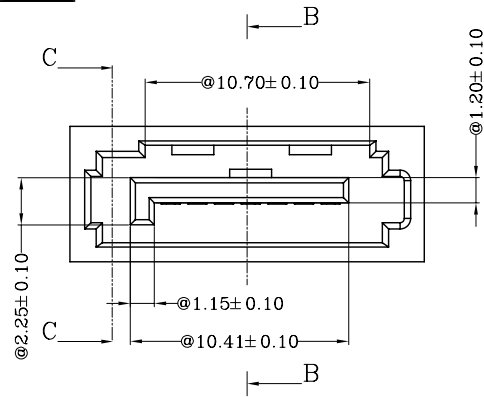

注意:

- 一.儲存環境:-20C°~85C°.
- 絕緣阻抗:100Mohm/Min.
- 耐壓測試:500V AC,時間1分鐘(MAX).

二.材料:

- 1.主體材質:PA6T G/F UL94V-0.
- 2.端子/魚叉材質:C2680R-EH
- 3.電鍍:先鍍全霧錫110u"~120u",后局部鍍金,測點鍍金足金1u",15u",30u"
- 4.魚叉:50u"鎳打底,鍍全霧錫:100u"MIN
- 5.帶@標記為重要尺寸
- 6.單PIN端子保持力0.3KG(電鍍品)
- 7.編碼原則:

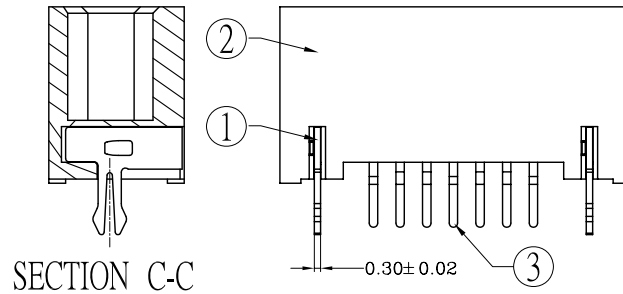
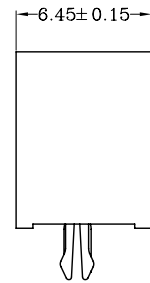
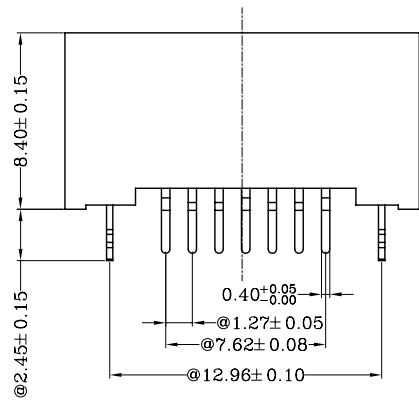

831M30705*****01

- 05 青銅足金15u" } 943 表示 黑色
- 29 青銅足金1u" } 1131 表示 紅185C
- 06 青銅足金30u" }

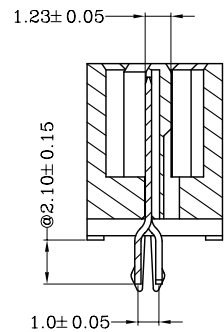
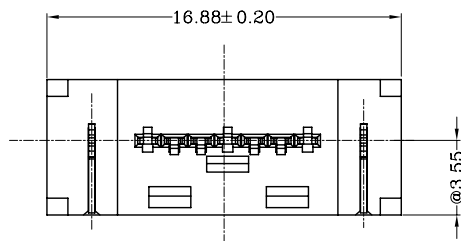
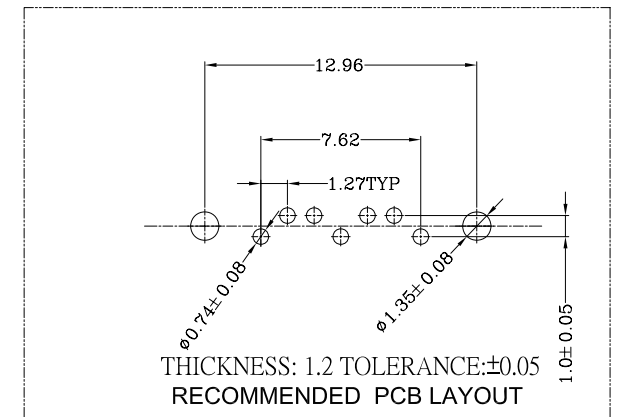

SECTION B-B

KEENTOP

CHING JIHMOLDING CO., LTD
KEENTOP INTERNATIONAL ENTERPRISE CO., LTD

ITEM

SATA 7P PLUG CONN.